

Original article

# Soft metal blanket with optional anti-sloshing conceptual designs to improve pressure control for floating and land-based liquefied natural gas tanks

Maksym Kulitsa<sup>1\*</sup>, David A. Wood<sup>2</sup><sup>\*</sup>

<sup>1</sup>Independent FSRU Operations Consultant Odessa, Ukraine

<sup>2</sup>DWA Energy Limited, Lincoln, United Kingdom

(Received December 5, 2019; revised December 15, 2019; accepted December 16, 2019; available online December 19, 2019)

**Citation:**

Kulitsa, M., Wood, D.A. Soft metal blanket with optional anti-sloshing conceptual designs to improve pressure control for floating and land-based liquefied natural gas tanks. *Advances in Geo-Energy Research*, 2019, 3(4): 424-447, doi: 10.26804/ager.2019.04.09.

**Corresponding authors:**

\*E-mail: dw@dwasolutions.com (D.A. Wood)

**Keywords:**

Liquefied natural gas tank pressure influences and controls floating storage and regasification units improved boil-off gas handling ship-to-ship transfers offshore LNG tank anti-sloshing

**Abstract:**

A conceptual design for an additional in-tank system in liquefied natural gas (LNG) tanks (in offshore or land-based plants) is proposed for efficient control of tank pressure. This system involves simple supplementary components to standard boil-off handling systems. The design concept builds upon the recently recognised duality in tank pressure behaviour in large LNG tanks. Such behaviour is exploited to promote conditions where tank pressure naturally trends to lower levels and limits the significant and abrupt pressure increases that would otherwise occur from time to time during routine operations. The concept involves a soft floating metal blanket, which involves simple low-cost components, requires no additional power to run, is easily retrofitted to and removed from existing tanks. The construction modifications for tanks required are minor and could be beneficial to both land-based and offshore plants. In offshore plants this system is suitable for sheltered locations where LNG cargo sloshing is not an issue. The design concept can though be modified as a more complex and connected structure (an anti-sloshing floating soft metal blanket) to provide combined anti-sloshing and pressure-control capabilities for offshore applications. Both concepts provide their greatest potential benefits to offshore floating storage and regasification units and floating storage units with tanks constrained by tank strength design limits, typically those converted from LNG carriers. Additionally, the solutions presented have direct relevance to shore-based LNG tanks due to their simpler geometry and sloshing-free status.

## 1. Introduction

Natural Gas (NG) today is becoming increasingly used as a cleaner fuel option to other fossil fuels and as a back-up to renewable power. The NG trade involves large and increasing volumes of gas transported as liquefied natural gas (LNG). Current offshore infrastructure solutions related to LNG are more available and flexible due to the development of a rapidly growing fleet of floating storage with or without regasification units (floating storage and regasification units (FSRU) and floating storage units (FSU)). This growth is in response to increased demand and new locations of gas supply and demand. To cope with further fleet expansion, a large number of conversion projects are likely to be sanctioned in coming years to transform existing LNG carriers (LNGC) into FSRU and FSU. The advantage of such solutions is flexibility, short development time to implement and lower costs than large-

scale land-based storage and regasification terminals. However, these LNGC conversions have the disadvantage that their tanks were designed for lower pressures that are better suited to transportation scenarios. The maximum operating pressures of such tanks is lower than modern purpose built FSRUs, which typically incorporate more expensive and stronger tanks that typically result in lower operating costs. Such low-pressure limits for the tanks of FSRU conversions result in significant cargo losses in the form of boil-off gas (BOG), which is wasted (i.e., not used for commercial or power generation benefits) to control tank pressure during routine FSRU and FSU operations, particularly ship-to-ship transfers.

FSRU operations do not have a long history with the first vessel operational in 2005. Understanding of their complex tank pressure trends, particularly during ship-to-ship transfers (STS) is limited. This means that few and focused pressure control measures have been developed specifically focusing



on FSRU operating conditions. Modern FSRUs are typically built with tanks of 700 mbarg<sup>1</sup> maximum allowable relief valve setting (MARVS). Such specifications generally overcome most issues relating to tank pressure control as such tanks have tank pressure limits able to cope with the tank pressure increases that typically occur during STS operations and rollover events. However, all FSRU conversion vessels, i.e., modifications to vessels originally constructed as LNG transportation carriers (LNGC), or older FSRUs constructed with tank pressure ratings of only 250 mbarg MARVS have less tank pressure head room to cope with typical FSRU tank pressure amplitudes without huge losses in cargo, including occasionally gas venting. FSRU conversions from LNGC have the advantage that time to convert them is about three-four times less than for building a new FSRU, and they are substantially cheaper.

An inherent problem for FSRU with low tank MARVS (~250 mbarg) is the frequent need to use cargo waste equipment, such as Steam Dumps (SD) or Gas Combustion Units (GCU) in order to control tank pressure and maintain it at a safe level, particularly during STS operations. STS transfer rates are often limited to no more than 6,000 m<sup>3</sup>/h for such FSRU due to tank pressure and BOG-handling capacity constraints. Additionally, some LNGC that are likely to be converted to FSRU in the future are not steam powered, but dual fuel diesel electric (DFDE) driven or with Tri-fuel (TFDE) and, potentially those with M-type-electronically-controlled-gas-injection (MEGI/XDF) engines (Olsen, 2016; Cook, 2017; Liquefied Gas Carrier, 2019). In such cases BOG utilization should be much less compared to steam-powered vessels, potentially leading to much greater BOG losses in safety equipment (as GCU/SD). This should be especially so during STS operations, compared to existing steam-powered FSRU. However, due to poor tank operating practices, actual absolute gas consumption figures may be the same for these different vessel types, cancelling out the potential advantages of the low-BOG DFDE/MEGI vessels.

As well as efficiently managing STS transfers and exploiting tandem-pressure conditions during such operations (Kulitsa and Wood, 2017a, 2017b) FSRU operators require enhanced knowledge and skills about LNG behaviour in FSRU tanks and tank pressure duality (Kulitsa and Wood, 2020). Such focus and understanding can significantly reduce unnecessary cargo loss and limit GCU/SD equipment usage as essential responses, thereby bringing commercial and operational benefits. Gas losses caused by the low-pressure limits for the tanks of FSRU have been documented in detail (Kulitsa and Wood, 2017c, 2017d; Wood and Kulitsa, 2018).

Here, we present a simple, practical and effective conceptual solution for FSRU/FSU with prismatic membrane tanks, rigid MOSS-type tanks and shore-based tanks to better control tank pressures by exploiting LNGs pressure-duality behaviour. The proposed system could also be beneficial for any FSRU with tanks rated at 700 mbarg MARVS. However, it would be most beneficial in 250-mbarg-rated tanks. It provides an easy

to install physical and semi-flexible barrier between the liquid and vapor in a LNG tank. Its placement has a dual objective.

- 1) To keep tank pressure floating dynamically well below the prevailing saturated vapor pressure (SVP) of the LNG bulk in the tank, i.e., causing tank pressure to *dip*\* and exist at lower tank pressures than it would without the system, by partially inhibiting and delaying evaporation from the LNG liquid surface.
- 2) To enhance condensation of natural gas vapor at the LNG liquid surface, in circumstances where tank pressure becomes raised above the saturated vapor pressure (SVP) of the LNG bulk, thereby causing tank pressure to *sag*\*. This action is particularly effective and beneficial when tank pressures tend to be *packed* (overpressure), as they typically become during most STS transfer operations.

Modern purpose-built FSRU may also be fitted with such systems. Their tank pressure can be effectively managed with appropriate operating strategies and powerful recondensing systems. However, recondensing systems consume energy when operating, whereas the blanket solution proposed reduces energy consumption and operating costs related to tank pressure management and reduces the use of recondensing systems.

\*Note that the term *tank pressure sag* is used here to mean a non-linear upward pressure trend with a convex-downwards shape and/or pressure trend held above and near the SVP of the LNG bulk in tank overpressure conditions. On the other hand, the term *tank pressure dip* is used here to describe the effect when tank pressure declines and is held significantly lower than the SVP of the LNG bulk.

## 2. Tank pressure duality behaviour in large LNG tanks

Details of the duality behavior in LNG tanks are provided elsewhere (Kulitsa and Wood, 2020). Changes to the physical properties of LNG in containment tanks is controlled by the physical laws applicable to any condensed cryogenic gas in a closed system when the vapor phase is in contact with its liquid phase. In such a system the LNG is slowly and continuously heated. LNG emits vapor at various rates in convection boiling mode from just the liquid-gas interface at the liquid surface (Cengel and Ghajar, 2014). The liquid LNG mass immediately adjacent to heating surfaces (e.g., tanks walls and bottom) is warmed by heat ingress and becomes slightly less dense. This causes it to rise in the tank until it reaches the liquid surface. At that surface the excessive heat is released as a BOG flash into the tank vapor space (Kulitsa and Wood, 2018). The liquid portion of LNG that has released the BOG flash is cooled by that event, thereby becoming denser and sinking towards the centre of the tank. This process sets-up convective currents and sub layers within the liquid bulk of the LNG. These convection currents effectively maintain the entire mass of LNG in a tank (i.e., the LNG bulk) at the same composition and temperature (i.e., a homogenous state).

<sup>1</sup>bar is a unit of pressure equal to 0.987 standard atmospheres; m refers to milli bars where 1mbar = 0.001 bar; g refers to gauge distinguishing it from absolute pressure

There is a surface layer at the vapor-liquid interface that possesses special properties. This is referred to as the LNG surface film (or the Hashemi-Wesson layer (Hashemi-Wesson, 1971; Paine et al., 2014)). It is always in thermodynamic equilibrium with tank pressure (Bates and Morrison, 1997) but is often recorded not to be the same as the SVP of the LNG bulk. The process by which this evaporation occurs is considered to involve mass integrating with the surface film and then evaporating through that film (Laciak, 2015). Heat and mass exchange takes place between vapor and liquid across this boundary layer/surface film, which is slowly flowing in two dimensions (Weyburne, 2006; Weyburne, 2018), and between the film and slow convection currents within the LNG bulk. This film plays a crucial role in vapor and liquid interactions in real LNG tanks influencing the prevailing tank pressure at any instant in time. Tank pressure is also affected by the SVP of the LNG bulk but its influence is controlled through the prism of the surface film and depends on external processes conducted on the tank content.

Prevailing tank pressure is the outcome not only of LNG composition and temperature but also the combined effect of all processes that are occurring in the tank (i.e., BOG evacuation, loading new LNG, taking LNG out for regasification feed, etc.). In practice, actual tank pressure is almost never the same as the LNG bulks SVP; it can rise to become much higher, or it can float just below it despite rigorous actions of the operator in attempts to reduce it further.

The LNG surface film tends to react rapidly, striving to achieve equilibrium with the prevailing tank pressure, and vice versa, such that tank pressure responds to the LNG surface films prevailing condition. The two conditions (i.e., tank pressure and the surface film) are interrelated and influence one another. The LNG bulk also affects tank pressure over time, but it does so at a very slow, practically imperceptible pace.

### 3. Physical and thermodynamic principles underpinning the floating blanket concept

The phenomenon of duality of pressure behaviour in FSRUs LNG tanks, observed on many FSRU during commercial operations depends on a number of influencing factors (Kulitsa and Wood, 2020). Two key characteristics of this pressure duality are:

- 1) If tank pressure drops below the SVP of the LNG bulk in the tank, the LNG surface film enhances evaporation in its ultimate efforts to maintain tank pressure at an equilibrium close to the SVP of the bulk LNG. The above effort is manifested by enhanced evaporation from LNG surface as molecules in the liquid state escape more easily into vapor space with reduced pressure. Ultimately, tank pressure becomes dynamically held floating just below the SVP of LNG bulk. It does this by stimulating evaporation from LNG surface film at a rate that is proportional to how much the tank pressure is below the SVP of the LNG bulk. While the LNG film itself becomes colder than the LNG bulk, it always remains in equilibrium with actual tank pressure, transitioning rapidly to achieve

that. Thus, whenever BOG extraction takes place from the tank, except during loading, the actual tank pressure equilibrates to just below SVP of LNG bulk. It remains there floating dynamically balanced and prevented from further decline by the changing evaporation rate. Dynamically lowering tank pressure further is not possible without a drastic increase in BOG evacuation rate by several fold. This is typically not possible due to BOG handling equipment capacity limitations. However, there is a way to reduce the rate of evaporation by reducing the evaporation mirror. The proposed free-floating, metal blanket effectively reduces the available LNG surface area over which natural evaporation can occur. This allows prevailing tank pressure to decline further with reference to the SVP of the LNG bulk. It increases the evaporation rate until a new pressure equilibrium is achieved.

- 2) If tank pressure rises above the SVP of the LNG bulk then condensation prevails at the surface film. However, the condensation that occurs is broadly limited in mass and the vapor space can be physically compressed (or packed) similar to the effects of a piston. During typical FSRU operations (loading during STS transfers), tank pressure may rise almost linearly, uninhibited by the minor amount of condensation occurring at the surface film. The film ultimately acts as a partial barrier that prevents effective condensation. However, the outcome is different if the surface film is mechanically broken, or, in some way, partially disrupted, by some external force (e.g. top loading or spraying or cargo rollover etc.). In cases of film disruption, it would not be possible to compress the vapor space such that tank pressure rises high above the SVP of the LNG bulk, in the manner described when the surface film is acting as a piston. Rather, condensation would always keep tank pressure dynamically stabilized slightly above the SVP of the LNG bulk.

The proposed concept substantially reduces the free LNG surface film by covering the surface with a flexible metal layer. That layer acts effectively as a condenser (i.e., permanent condensing surface), with much higher capacity than that achievable by the LNG surface film naturally, and less variable in its condensation capacity. Fig. 2 illustrates this effect for packing/overpressure conditions when the full-size LNG film is being vigorously disrupted/destroyed, leading to enhanced condensation and a substantial sag in the tank pressure trend (i.e., at higher rate than natural condensation) on liquid surface only. Similar and more pronounced impacts would be easy to achieve with a metal surface during any type of STS transfer.

The physical surface blanket concept proposed would enhance the thermodynamically driven effects described. It would enhance tank pressure control capabilities for the same BOG handling equipment capacity. Doing so by effectively replacing a significant area of the LNG surface film within the tank with a surface prone to preferentially promote condensation and slowing down the BOG evaporation rate.

The effect of that floating metal surface would be to reduce evaporation from the LNG liquid in a similar way to floating mechanisms exploited to reduce water evaporation in some reservoirs. That principle was adopted in Los Angeles in 2015 by covering a large water reservoir with some 98 million 4-in black plastic balls to reduce evaporation in hot arid conditions (Howard, 2015) (300 million gallons of water saved each year from reduced evaporation from a reservoir with a surface area of 174 acres).

#### 4. Blanket concept to reduce evaporation surface area and increase condensation rate on the LNG surface to better control tank pressure

The quantity of BOG generated in an LNG tank depends on heat ingress plus heat generated within the tank during FSRU/FSU operations. However, the evaporation mirror (i.e., the evaporation area of the surface film) is also an important factor. Larger surface areas readily emit more BOG faster than smaller surface areas within a specific time interval at the same conditions. Consequently, if the evaporation surface area is small it is constrained to emit relatively less BOG over a time period. If its latent heat of evaporation is unable to remove all the heat ingresses to the LNG bulk, in such conditions, the LNG bulk will accumulate the remaining heat and slowly warm up. This change in bulk LNG condition will increase its SVP and in turn influence tank pressure. It potentially leads to tank pressure increases if, in static conditions, no BOG extraction takes place (i.e., not typically the case of operating vessels). As FSRU discharge progresses, the quantity of bulk LNG in the tanks is reduced. Consequently, the same amount of removed BOG has a greater cooling effect on the surface film and also remaining LNG mass as it reduces in volume. This eventually comes into balance and warming of the LNG stops and cooling begins, if the quantity of BOG removal is large enough.

The core practical benefit of reduced evaporation mirror lies in its ability to extract a large BOG mass from a smaller evaporation mirror. This stimulates a greater dip in the tank pressure that helps to maintain that pressure dynamically at lower values during tank operations. If a full evaporation mirror exists (without a blanket), then a tanks prevailing pressure will dynamically reduce and float at about 30-50 mbar below the SVP of the LNG bulk at large and very large BOG extraction rates. At a reduced evaporation mirror (with a blanket) the tank pressure should dip and be floating well below SVP of LNG bulk; much further below the SVP than would be the case without a blanket. The principle of pressure descent below LNG bulk SVP is same, except that the resulting amplitude of that descent varies according to the exact magnitude of BOG extraction takes place. Three distinct tank pressure enhancement effects result from using a blanket.

##### **Effect 1: Effect related to reduced evaporation mirror while maintaining large BOG extraction rate from a tank.**

A benefit of creating a small evaporation surface, is that standard BOG handling systems can remove a large flow of vapor mass from a tank, while reduced evaporation tends to occur through the diminished vapor/liquid interface area.

Taking more vapor from the tank than is evaporated from the liquid will create a dip in the tank pressure trend compared to the case with a full evaporation area. A small evaporation area struggles to emit the necessary amount of BOG immediately, but eventually it will do so because tank pressure has declined, ultimately achieving a new balanced state at lower tank pressure. In this case, the tank pressure will dip and find a new balanced floating value directly related to the amount of BOG removed from the tank. This effect is due to pronounced cooling of the surface film, causing films SVP and the interrelated tank pressure to dip much more than it would do so naturally.

Without a blanket a natural decline of dynamic tank pressure below the SVP of the LNG bulk SVP occurs. Tank pressure floats at about 30-50 mbar below SVP while large BOG evacuation rates persist. This is due to the surface film acting as a mesh that slightly reduces evaporation from the underlying LNG bulk. With the blanket in place, the evaporation rate is much more restricted and the imbalance this creates between BOG evaporated versus BOG removed from tank causes tank actual pressure to decline further. Falling tank pressure in turn enhances BOG evaporation which in turn cools the small surface film more and more as it has to emit more BOG. Consequently, dynamic tank pressure equilibrates with the colder film at a level where the evaporated BOG equals the BOG extracted from the tank. The practical effect of this is that the dynamic tank pressure would be floating at 80-100 mbarg rather than 200 mbarg, despite the thermodynamic state of the LNG bulk (i.e., its SVP) ultimately striving to establish tank pressure at 200 mbarg.

When the full evaporation area is present, in the case of a BOG-handling system trip, tank pressure would rise rapidly to the current SVP of the LNG bulk, generally reaching that state within 15-30 minutes. An additional benefit of a reduced evaporation surface, is that tank pressure would increase at a much slower rate towards the SVP of LNG bulk, allowing the operator more time to tackle and respond to rising tank pressure. FSRU operations involve varying evaporation rates from the LNG vapor surfaces that rarely remain constant over time and are often large. Tank pressures, most of time, would be maintained in a deeply dipped state. This provides spare pressure headroom that is beneficial in cases of equipment trips. Effect 1 is generally applicable to tank conditions where BOG extraction is the same or exceeds, in energy terms, heat ingress into the tanks through their containment walls.

##### **Effect 2: Consequences of reduced BOG extraction rates from a tank with a reduced evaporation mirror.**

A relevant analogy is water evaporation rates at room temperature which depend on surface area. The same amount of water placed in a saucer evaporates faster than water placed in a bottle with a smaller evaporation surface area. This occurs because of the different evaporation mirror sizes.

The reduced BOG extraction rates considered here are such that they do not compensate for the natural heat ingress into the tank. Likewise, for LNG in a tank, reduced evaporation surface area causes less BOG to be evaporated as a natural process, unlike the evaporation in Effect 1. Tank dynamic pressure will float at a value still significantly below or near the

SVP of LNG bulk depending on the BOG extraction rate, but typically closer to the SVP compared to Effect 1. Ultimately, lesser BOG extraction from a tank will create a less significant dip in the tank pressure trend, leading to lesser BOG able to evaporate, compared to same condition with a full evaporation mirror. This causes lesser heat removal from the LNG bulk. If the quantity of heat removed from the tank falls below the quantity of heat ingressing into the tank, then the LNG bulk will slowly warm up causing its SVP to rise. The increased SVP of the LNG bulk, in turn, slowly stimulates evaporation and influences the prevailing tank pressure in the long run. The overall effect observed is a less deeply dipped pressure condition with tank pressure slowly increasing in parallel with the SVP of the LNG bulk over a long time. The slow rate of change is due to the large mass of the LNG bulk and time needed for it to warm up. The overall advantage is two-fold: 1) tank pressure still dips below the SVP of the LNG bulk despite a low BOG extraction rate, not as for Effect 1, but lower compared to the case of a full evaporation mirror; and, 2) significant extension to the time taken for tank pressure to rise to high levels. Its primary operational benefit would be to delay the moment at which BOG extraction needs to be increased by use of GCU/SD to control tank pressure for safety reasons. For example, in the case of FSRU low regasification sendout rates. The operating patterns of FSRU involve intermittent periods of low gas sendout rates. Thus, the system indirectly helps to minimize commercial loss by reducing gas consumptions in the GCU/SD, even in adverse conditions of operation.

**Effect 3: Effects of enhanced condensation by increasing the condensation area when the tank experiences overpressure condition.**

During some operations, such as STS, the tank vapor space is often being physically compressed because vapor extraction does not compensate for liquid volume inflow and fast vapor space reduction. In such conditions, the tanks prevailing pressure may increase significantly above the SVP of LNG bulk. In such overpressure conditions, when the prevailing tank pressure is higher than the SVP of the LNG bulk, condensation takes place on the LNG surface film, in limited quantities varying from case to case, causing tank pressure to sag (Figs. 1 and 2). Its effectiveness typically declines as STS transfers progress. The LNG surface film regulates heat exchange between the LNG bulk and the tanks vapor space. The film saturates rapidly (due to its small mass), responding to tank pressure change induced by compression of the vapor space, it broadly restricts effective heat exchange, i.e. the surface LNG film displays blanket-like qualities in relation to the LNG bulk. This means that the large underlying mass of the LNG bulk plays a reduced role in regulating actual tank pressure.

The LNG film absorbs a small amount of the tank vapor to reach equilibrium temperature such that its SVP equals the prevailing tank pressure. Eventually, due to this effect, the tanks vapor space becomes increasingly packed or compressed. This is particularly likely to occur during STS transfers, when prevailing tank pressure often rises rapidly, following an almost linear trend to high levels, in a similar way to vapor being compressed in a cylinder by a piston. During some STS transfers

tank pressure rises non-linearly (i.e., packing conditions, Fig. 1). Cargo tank pressure trends to display a time-limited sag (non-linearity), which is particularly pronounced in the early stages of STS transfers (i.e., up to about 50% of the STS completed). This is due to enhanced surface condensation that occurs at the LNG surface when the film is disturbed (Fig. 1) or significantly disrupted (Fig. 2) due to bottom loading of a light cargo into a heavy LNG heel cargo (Kulitsa and Wood, 2020). The pressure sag effect would be stronger than one illustrated in Fig. 2 if surface condensation capacity could be increased. A metal blanket, acting as a more effective condensation surface than the LNG film, would achieve this. In that case, tank pressure would be held dynamically floating at some value above the SVP of the LNG bulk. Tank pressure would be prevented from increasing, or at least the pressure increase rate would be significantly slowed down, despite the vapor space becoming compressed. For example, tank pressure could be dynamically held stabilized at 170 mbarg instead of rising to a tanks safety limit level of 200-210 mbarg, where GCU/SD would be utilized or the STS transfer rate reduced. In contrast to the LNG film, a metal blanket on the LNG surface would provide this effect continuously whenever overpressure condition exists in the tank. However, the effectiveness of the blanket would be somewhat reduced in the case of LNG stratification forming during STS transfers. In such cases a smaller pressure sag would result.

We propose a concept to upgrade existing LNG tanks, i.e., by installing a free-floating, fragmented, soft metal layer. This layer would mimic a blanket to cover the LNG surface. This is similar to the Samsung Heavy Industries (SHI) design for an LNG ABAS blanket involving one-metre cubes of Basotect foam (MarineLink, 2013) used as an anti-sloshing and BOG inhibiting device (Lee et al., 2014, 2016). The system proposed does not focus on anti-sloshing but on instigating more effective tank pressure management. Rendering BOG natural evaporation inefficient, or reducing its rate, by reducing the LNG surfaces evaporation mirror, the concept promotes the lowering of prevailing tank pressure during operations. It enables tank pressures to be held much lower than would be the case without the blanket installed, i.e., the pressure dips as described in Effects 1 and 2. Also, by increasing the efficiency and scale of condensation at the LNG surface, the large condensation surface of the blanket inhibits tank pressure from rising significantly above the SVP of the LNG bulk. The concept is a self-regulated system as it exploits and enhances the natural behaviour and pressure response observed in LNG tanks in over-pressured and under-pressured conditions (in relation to the SVP of the LNG bulk).

## 5. Free-floating soft metal blanket (FSMB) surface design

The thickness of the surface LNG film is limited to about 5 mm (Deshpande et al., 2011), so free-floating elements should easily be partially immersed deep below it. To establish the optimum performing shapes and materials for the floating elements of an FSMB, it is necessary to consider:

- the thickness of the surface LNG film

### LNG Temperature, Tank Pressure and Level Trends in FSRU during STS Transfer with Packing Conditions

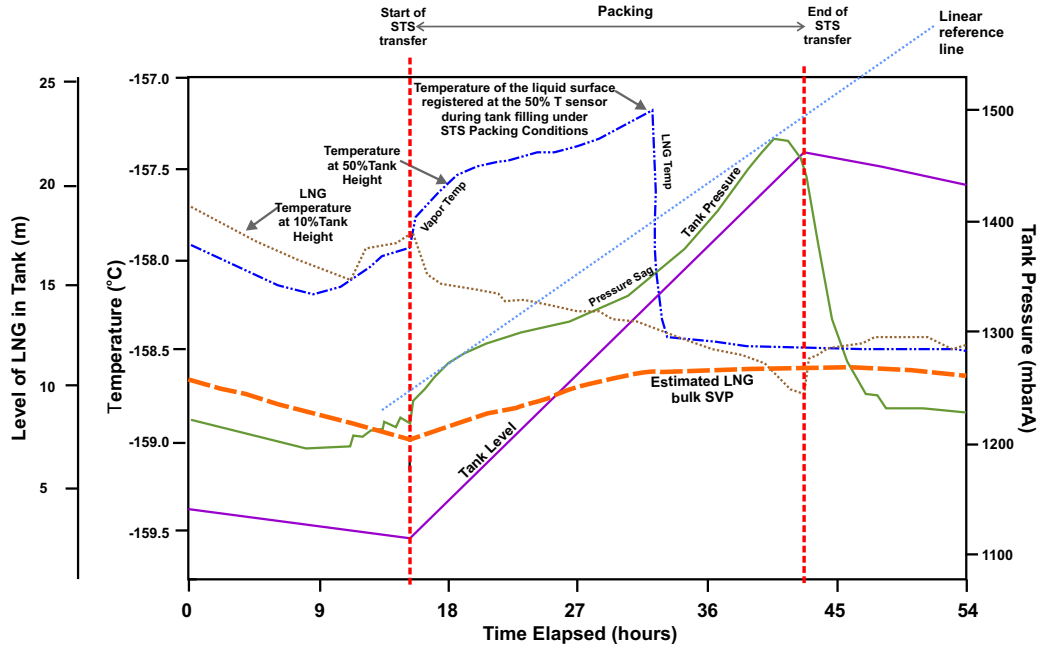
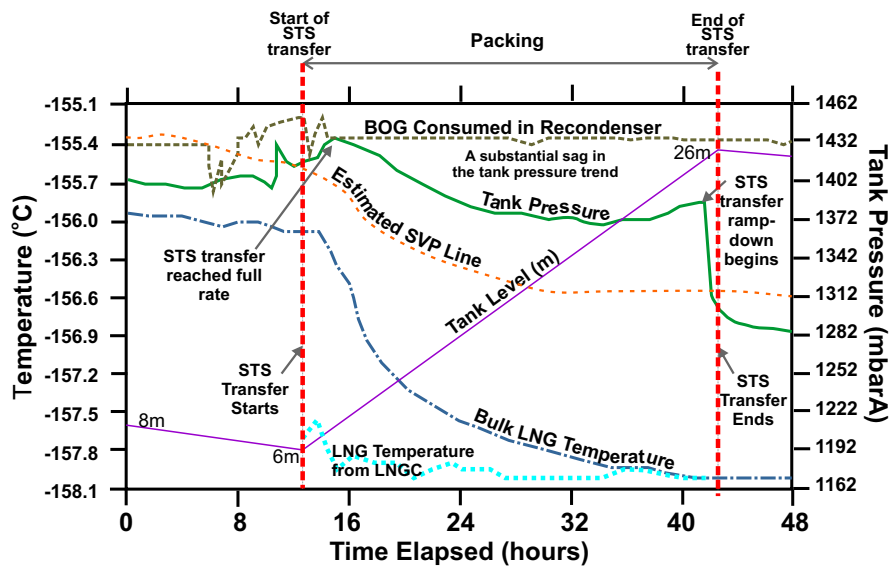

Fig. 1. Sagged tank pressure and temperature trends during packing conditions for STS mix case (no stratification formed) in overpressure condition observed during actual FSRU STS operations without a surface blanket. An additional example of this common behaviour is shown in Appendix 1.

### FSRU Tank Pressure Decline during a Special STS transfer Mix-Packing Case



Note: FSRU tank pressure decline began at high tank pressure, far above the SVP of the LNG bulk of the mixed LNG in the FSRU tank once the STS transfer is completed.

Fig. 2. STS mix (special case of high-density LNG driven surface film destruction process) in severe packing/overpressure conditions. The tank pressure trend rather than rising almost linearly tends to decline displaying a substantial sag and is maintained dynamically closer to the SVP of the LNG mix. The tank pressure effect illustrated is similar to what would result using a metal blanket.

### Thermal Conductivities of Selected Metals Extended to Cryogenic Temperatures

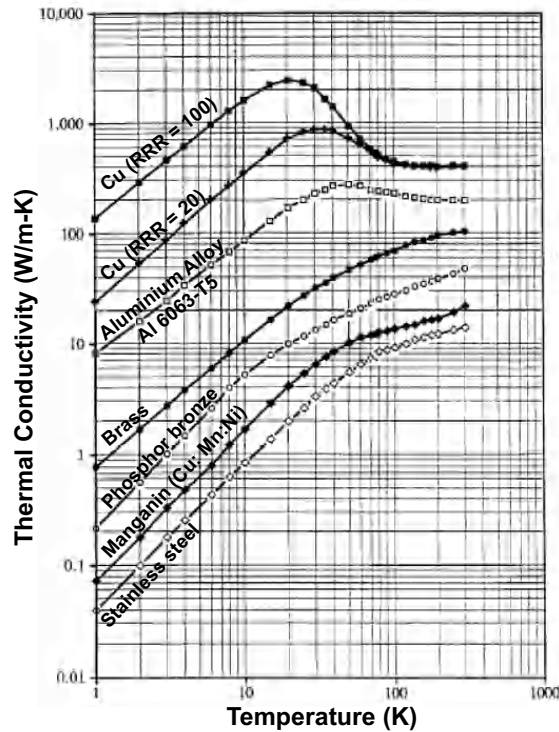

Fig. 3. Thermal conductivity of metals including at cryogenic temperatures. Modified after Polinski (2010). RRR= relative resistance ratio.

- its interactions with the vapor phase and convection currents within the LNG Bulk
- its capabilities to enhancing cold transfer from LNG bulk to upper surface of metal floater thereby promoting condensation from the vapor phase
- its impacts with the membrane tank (i.e., it must avoid sharp edges to avoid damage)
- the magnitude of immersion draft. It needs to penetrate deep into the LNG below the surface film and not just float on the surface (this enhances cold transfer from below the LNG surface film)

It is important to select materials for the metal floating components that are most fit for purpose. The materials must:

- be cryogenic resistant metal
- have high heat conductivity
- be as light as possible to minimize floating weight of blanket and reduce risk of tank damage in case of accidental sloshing
- be easy to shape, mould and fabricate into suitable designs
- achieve attractive cost to benefit ratios

We suggest that it is worth rigorously testing a range of metal alloys able to resist cryogenic temperatures, including those of alumina and stainless steel, for their suitability to construct effective free-floating soft metal objects (Fig. 3). The metal surfaces (at least the condensing parts) need to be polishable to achieve a glossy, mirror-like surface, rather than have rough surfaces. The use of metal may not be obligatory, if

other special materials are available that possess resistance to cryogenic temperatures, similar strength to metals with good heat conductance and polishable surfaces. In the absence of detailed tests on alternative possible materials it is currently considered that metals are most suited to this purpose. The floating shapes must not be large and should be light with a draft (immersion into the LNG deep below the surface layer), of at least 50 percent of the shapes height. This would effectively reduce the LNG surface film to a minimum and efficiently conduct cold from deep within the LNG bulk.

Numerous potential shapes for the free-floating elements of the FSMB were evaluated (Appendix 2). Viable shapes need to provide deep immersion into the liquid LNG, such that heat transfer by conduction would be enhanced from LNG sufficiently below the surface film. This would significantly enhance condensation. The surface of the metal objects would need to be polished to allow condensed liquid droplets to flow-off them easily into the LNG surface rather than remain on the metal itself, thereby acting to reduce condensation. Also, it would be necessary to ensure that most of the surface area of the evaporating film was covered by the floating metal component, as this would minimize evaporation from that surface.

Several floating metal shapes that we consider are worthy of rigorous performance testing for this purpose are discussed. For FSRU/FSU with membrane prismatic tanks the blanket needs to change size with the operating LNG level and tank height. In such conditions the ideal shape is likely to be a hollow ball shape or semi-ball shape with fins. A round

base would be the simplest to fabricate and could provide adequate fit-for-purpose cover of about 80% of the surface. More surface coverage is possible with shapes of a smaller size and an excess number of individual shapes. Thermodynamic tests are required to determine which configuration is the most effective. All parts of any shape selected need to have rounded corners (i.e., no sharp points) in order to avoid damaging the tank membrane. Internally, the floating components may have additional structures and materials that would enhance heat flow by conduction from the lower side in the bulk LNG to the upper side in the vapor phase (i.e., more cold would be conducted from the LNG into the vapor phase and condensation duration would be extended).

In contrast to the anti-sloshing ABAS Blanket system (MarineLink, 2013; Lee et al., 2014; Lee et al., 2016), the free-floating soft metal blanket (FSMB) concept so far described is not intended to prevent sloshing. As FSRU/FSU typically tend to be moored in sheltered areas, sloshing is not a major operational issue for them. When FSRU, with such a system installed, are moved in open waters it would be necessary to sail them with no LNG in their tanks (no heel) or fully loaded. Land-based tanks do not suffer sloshing but can significantly benefit from the free-floating metal blanket so far described. The floating elements of our system are not connected but float freely on the LNG surface, the shape of which varies with the quantity of LNG in the tank. Such free-floating components would create a blanket over the entire liquid surface in the LNG tank due to their shape and gravitational force. Moreover, their design prevents them from piling up when sufficient floating surface available. One advantage of an untethered, free-floating blanket is that it may change its shape in accordance with the hexagonal shape of membrane FSRU/FSU tanks and provide the cheapest solution for shore-based tanks. An optimal number of shapes would cover the whole liquid surface at mid tank but pile up when the LNG liquid level enters the top and bottom sloping sections of the prismatic membrane tanks. As the floating components are made of metal material they are easy to fabricate, place into and remove from LNG tanks without the FSRU/FSU vessels having to return to a shipyard. A blanket of such structure is also damage resistant.

The vertical profile of the floating element should not be flat, but extend in a conical, cylindrical or spherical shape, in both directions (up and down), from the LNG liquid surface. This would ensure: 1) deep penetration downwards into the cold LNG bulk; 2) upward vertical extension into the vapor space to provide sufficient surface area to meaningfully enhance condensation of vapor; and, 3) with steep sides enabling condensed liquid droplets to flow swiftly off onto the liquid surface to maintain efficient condensation. Horizontal surfaces need to be avoided or kept to a minimum. A more detailed discussion of shapes considered for the floating elements and rejected for various reasons is provided in Appendix 2.

*Optimal shapes considered suitable for FSRU/FSU and land-based tanks are:*

- A simple metal sphere or semi-sphere with fins (ball) floating at the liquid surface immersed to the extent of

its radius. This would result in its central diameter (great circle) being at or close to the liquid surface. The total mass of a ball shape should be as small as possible so as to be safer for membrane tanks, i.e., cause less impact to the tank walls in the sloping. The most effective design evaluated consists of a ball with two separate semi-spherical chambers: 1) lower half is a partially open sphere with cuts through it-it achieves conductance and is floodable with LNG liquid; and 2) the upper half sphere is a floatation chamber providing the recondensing surface and immersion of its bottom part (Fig. 4; items 1 and 3)

- Full-size sphere with 2 chambers, one acting as a float, the other grooved for flooding and acting as an anchor (Fig. 4; construction 1 and lower item 3 to form a complete semi-grooved ball shape)
- Long egg-shape (widest part upwards) consisting of two chambers. The upper one is a polished semi-sphere and the lower one is a grooved, elongated, dull cone that is floodable with LNG. Such a shape is beneficial for deeper draft configurations with better cold transition capabilities from the LNG bulk

All designs would need to be self-righting to float only in a vertical position and be resistant to piling up one on top of the other. The proposed solution would only be suitable for membrane LNG tanks (non-spherical) where only minor modifications (such as steel mesh protection on the tripod mast and may be domes, spray coils) would be required to prevent the shapes becoming entangled with the in-tank structures (Figs. 5 to 8).

The uniform design that could work in any LNG tanks, FSRU or land-based (Figs. 5 to 8), is a ball (spherical) shape with two distinct semi-spherical chambers. The lower semi-spherical portion is floodable with LNG to assure submergence of fifty percent of the floating component in LNG. This enhances cold conductance to the upper semi-sphere, located primarily in the vapor phase, and designed as a float chamber. This upper, polished, semi-sphere acts as an effective recondensing surface covering as much as possible of the LNG surface. Shaped as a ball, it is easy to fabricate and has no sharp edges. This minimizes the chances of damaging the structural components within any LNG tanks. In detail the ball shape is actually a buoyant partially-open sphere that looks like a parachute from some side views (Fig. 4).

A ball shape is the easiest, simplest and cheapest to fabricate for this purpose. For FSRU/FSU deployment, its optimal diameter is estimated to be about a 10-20 cm diameter. It should also possess a low weight that results in about fifty percent height immersion into the LNG (i.e., for LNG relative density of between about 0.42 and 0.50). A buoyant-partially-open-sphere and buoyant-semi-grooved sphere designs are worth testing (Fig. 4). The latter would have less weight if fins (component 2) are not installed.

All designs are likely to perform better with small individual components rather than large ones. Large components pose greater risk of damaging the tank membranes. The GTT Mark III system is better suited to FSMB due to its stronger membrane minimizing the chance of damage. The GTT NO.



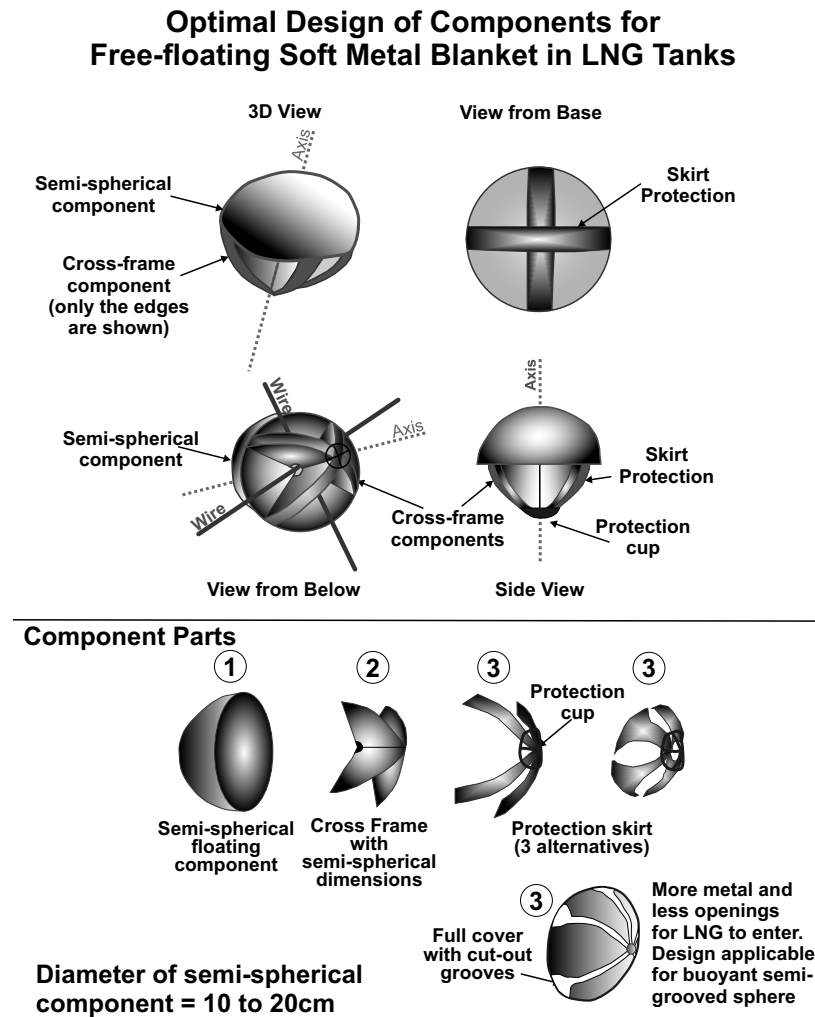

Fig. 4. Two optimal designs of components for free floating soft metal blanket (FSMB).

96 system involves a theoretical risk of that the FSMB components could bend the welded tongues on membrane strips (Fig. 5). To avoid tank damage, in the upper part of tank, in particular, individual elements of the FSMB should not be more than 20-30 cm in diameter (Fig. 6). Ideally, each floating element should be filled with a light heat-conductive material that would assist in heat transfer. Alternatively, they could have internal metal bridges inside hollow outer bodies to likewise assist heat transfer.

The number of floaters needs to be sufficient to cover the largest possible tank liquid surface area (i.e., typically the middle part of the tank on FSRUs). A small extra margin may be required to assure that all shapes are able to spread freely as a complete blanket. In the lower part of the tank excess of floating components will pile up slightly (due to the tanks shape). Most critical is in the upper part of tank where an inward slope eventually terminates at the tank ceiling. It is important to avoid floating element designs (e.g., ball/buoyant-partially-open-sphere shapes) being pushed into the ceiling as they pile up in that upper region of the tank and risking damage. These factors will influence the any floating element designs.

The largest sized floating component needs to take into account piling up in the upper part of FSRU tank when the tank is full of LNG (typically 98.5% of volume). Such piling up of the floating elements should not extend over a height of about two meters in the vicinity of the tank ceiling of membrane prismatic tank.

The objective should be to maintain the entire liquid surface in the LNG tank covered by the floating elements. These elements would then act as a moveable free-floating soft metal blanket (FSMB) adjusting its shape (while maintaining the blankets integrity) to fit the tanks shape and piling up excess floating elements as necessary. In such a configuration, the system would exploit tank pressure duality to its maximum, benefitting from effects 1, 2 and 3. It would provide meaningful commercial benefits by reducing evaporation from the liquid surface and acting to promote significant condensation during conditions when tank pressure trends above the SVP of the LNG bulk (e.g. during STS transfers). In practical terms, for a delivered LNG cargo with SVP between 100 and 150 mbarg, this would shift tank pressures from slightly above that SVP to substantially below it, thereby reducing gas consumed in the GCU/SD.

### FSRU Membrane Tanks are Suitable for Free-floating Soft Metal Blankets (FSMB) with Protection to Vulnerable Components

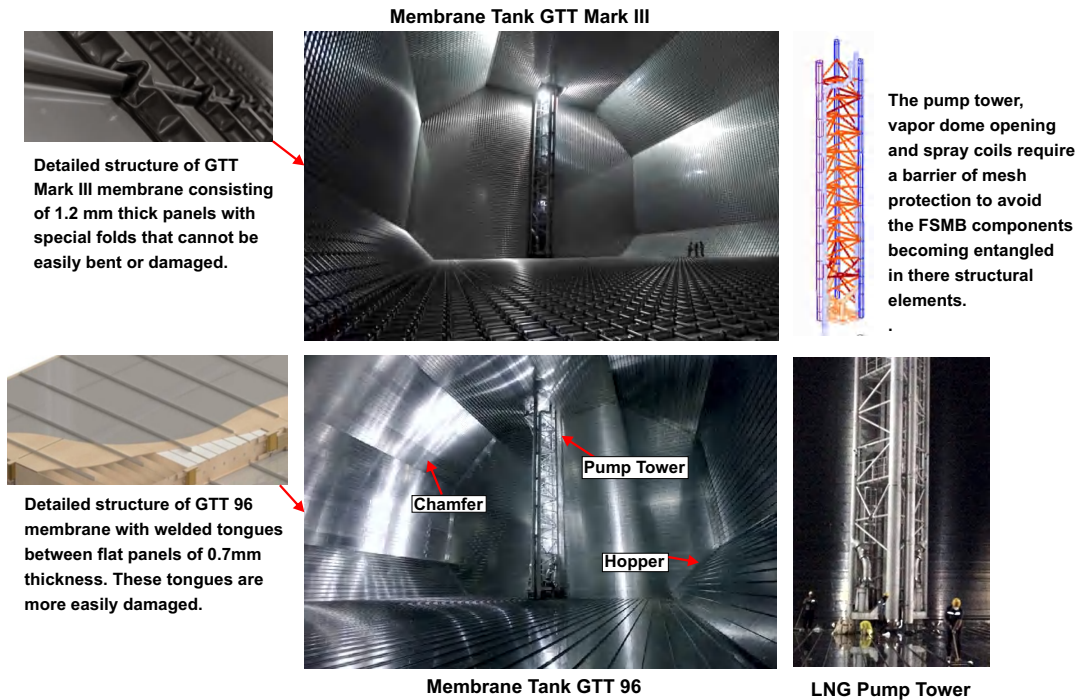

**Fig. 5.** Membrane prismatic FSRU/FSU tanks are suitable for the deployment of a free-floating soft metal blanket (FSMB) but certain areas of those tanks require protection from potential impacts from the free-floating elements. Images modified after GTT (2019).

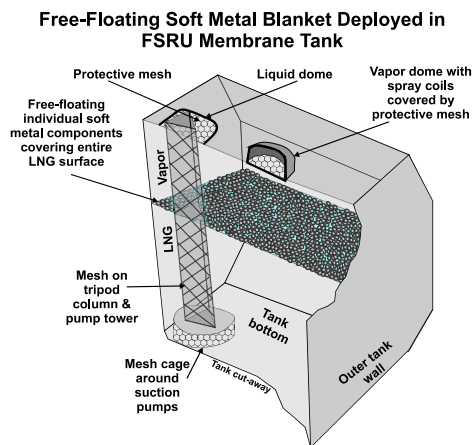

**Fig. 6.** Isometric view of free-floating soft metal blanket (FSMB) in membrane tank of FSRU/FSU.

## 6. Safety considerations and tank modifications required to accommodate a soft free-floating metal blanket

The key issue to cope with for free-floating elements is sloshing of the LNG cargo in the tanks during rolling and pitching of offshore FSRU/FSU and the in-tank wave movements that induces (especially those breaking off the tank wall) leading to frequent impacts on the tank walls and potential damage to them (Lloyds Register, 2009; Bureau Veritas, 2011; Liljegren and Lindahl, 2015). Significant cargo sloshing would cause a number of the floating elements to have impacts with

the membrane tank walls with increased force. Driven by rapidly moving waves in the LNG cargo, the oscillating wave actions would propel the floating elements into the primary tank membrane. As sloshing builds up momentum, the striking force of the elements into the tank walls would progressively increase leading to damage of the primary membrane, and risk damage to the blanket components themselves. Sloshing is not an issue for most FSRU/FSU that remain stationed in sheltered waters for medium-term and long-term contracts, according to current practice (e.g., 3-15 years), in contrast to offshore FSRU subjected to open-seas conditions.

Most operational FSRUs are moored long term in shel-

### IMO Type A LNG Tank Design for Marine Vessels is Suitable for Deployment of a Free-floating Soft Metal Blanket

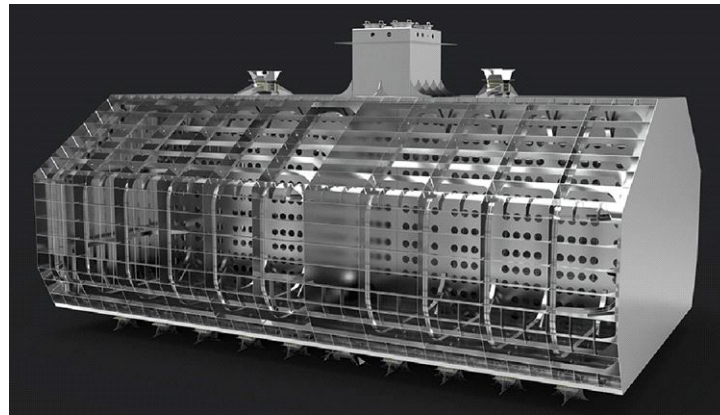

**Fig. 7.** IMO type A rigid prismatic tank for LNG is most suitable for the deployment of a free-floating soft metal blanket (FSMB) even for offshore locations as tank is strong and sloshing-free. Modified after DNV-GL (2019).

### Full Containment Land-based LNG Tanks are Well Suited to the Deployment of a Free-floating Soft Metal Blanket (FSMB)

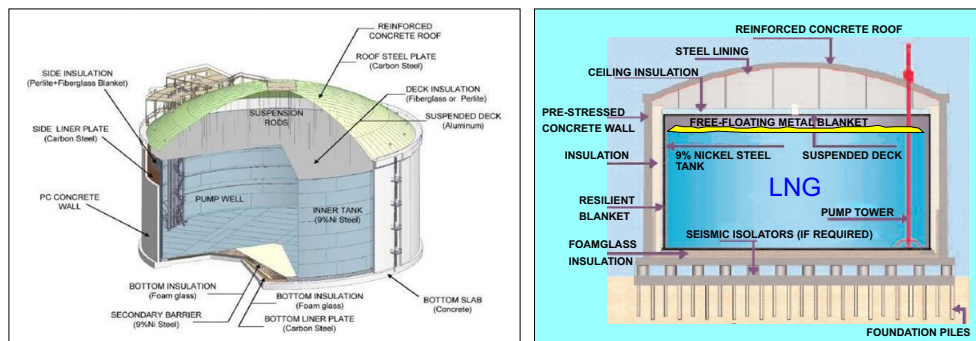

Only the pump tower would require wire mesh protection in the deployment of the FSMB

**Fig. 8.** Established designs for land-based full-containment LNG tanks where free-floating soft metal blanket is applicable with only minor protection modifications to the pump tower left side image after Pandey (2017).

tered sites protected from sea swell (e.g., harbours, sheltered jetties or inland waters). However, sloshing research would be required to establish the maximum rolling and pitching conditions that a vessels could tolerate equipped with free floating elements in its tank before risking tank damage. Consequently, the proposed solution is considered to be viable only for vessels moored in sheltered locations. The free-floating blanket design is simple and cheap, as it forgoes providing a sloshing damping effect and focuses upon enhanced tank pressure control, particularly while tanks are being filled (i.e., STS transfer for FSRU/FSU, but also tank filling in land-based LNG tanks). Also, the soft free-floating metal blanket system could be easily removed from tanks, when they are empty and free of gas, without the need to return to a shipyard to do so.

Additional measures are needed to prevent the floating metal shapes of the FSMB from stacking inside the tank structures (domes, safety valves, pump discharge column, tripod mast, etc.) and piping (possibly falling later from a height within the tank posing the risk of damaging the bottom

membrane). The tank tripod column would need to be fully wrapped in metal mesh, as would the bases of the tanks vapor and liquid domes.

## 7. Advantages and disadvantages of installing a FSMB blanket in FSRU/FSU tanks and shore-based tanks

### 7.1 Advantages

- Maintaining dynamically the prevailing tank pressure substantially below the SVP of the LNG bulk during periods when some BOG is being removed from the tank. The dynamically maintained tank pressure would be more than 50 mbarg below the SVP of the LNG bulk that naturally establishes without a metal blanket (i.e., 40-50 mbar maximum below SVP of LNG bulk when BOG utilization is about 10-12 t/h)
- Providing more time in situations when BOG extraction

from an LNG tank is temporarily interrupted, before tank pressure reaches equilibrium conditions with reference to LNG bulks SVP. Without this system, prevailing tank pressure is close to the SVP of the LNG bulk and tank pressure would increase to the LNG bulks SVP within about 15-30 minutes when BOG extraction is interrupted. Reducing the evaporation mirror with a metal blanket would significantly extend that period, providing operators more time to manage the evolving trend of a rise in tank pressure

- Useable on any ship with membrane or prismatic tanks including newbuild and FSRU/FSU conversions from LNGC. Installation is relatively simple.
- Slowing down evaporation from the LNG during rollover events. This would provide operators more time to manage the evolving trend of a rise in tank pressure associated with such events
- Inhibiting the magnitude of tank pressure increases during overpressured conditions by enhancing condensation at the LNG surface on the cold metal surfaces of the floating components. Tank pressure would be unable to rise significantly above the SVP of LNG bulk and the tank would generally not be able to persist in a typically packed condition (Cult of Sea, 2019), where tank pressure may rise fast and to unlimited high levels
- No operating costs once the system is installed
- Fabrication of hollow shapes (balls especially) is very easy
- Low capex cost and no modifications required to an existing LNG tank, such covering the vulnerable internal structures with steel mesh
- Most advantageous for 250 mbarg MARVS-rated tanks, especially for ships without steam powered engine rooms. This feature could significantly improve the competitiveness of 250 mbarg FSRU ships in current market conditions
- Saving of significant amounts of gas in the long run (i.e., less use of steam dump or gas combustion units by maintaining better tank pressure control)
- Facilitating higher STS transfer rates that otherwise would be not possible
- Acting as auxiliary for pressure control by recondenser or latent heat capture systems (LHCS). Such equipment could become additional rather than essential components for some FSRU. High-capacities recondensers may not be required with a floating metal blanket installed. In current operating modes it is an essential for many FSRU to have high-capacity recondensing equipment, and these contribute to higher operating costs of FSRU
- A floating metal blanket could ideally be applied in shore-based LNG tanks of cylindrical design
- Potentially such blankets could also be applied in IHI offshore group (IHI) self-supporting prismatic shape type B (SPB) and type A rigid prismatic tanks in open-ocean conditions, small LNG transportation or bunkering vessels and in LNG fuel tanks of LNG-powered ships
- Fitting (or removing) the floating elements to install (or change) such a blanket requires the LNG tank to be

opened. Although the floating elements could be placed in the tanks without the vessel entering a shipyard, the initial instillation of protection mesh around the vulnerable inner-tank elements would require remedial work in a shipyard

## 7.2 Disadvantages

- Risk of damage to tank membrane walls and floating metal components themselves during severe cargo sloshing
- Limited to FSRU/FSU moored in sheltered location. When FSRU are moved in open seas it would be necessary for them to sail with dry tanks (i.e., without an LNG heel cargo) or fully laden tanks
- System would require initial installation in a shipyard or dry dock to conduct the welding to install the steel mesh around the tripod column and domes (i.e., required in-tank modifications)
- LNG bulk sometimes would be at a higher temperature and SVP with the floating blanket than without it. This is because the LNG bulk would absorb more heat (during low BOG-consumption periods) from the vapor space through the floating blanket. However, in most circumstances, even at slow regasification rates, FSRU operations can easily cope with this. This condition could however lead to greater BOG loss during LNG cargo offloading from FSRU (e.g., reloading of LNG back to LNGC during a reverse delivery), although that occurs very rarely in the current operational routines of most FSRU
- Additional studies and tests are necessary to ensure that specific FSRU will generate enough natural BOG to maintain their tank pressure high enough to assure good suction pressure for compressors at high regasification loads. This is required because the capacity of the floating metal blanket cannot be regulated. The blanket would always perform at its full capacity potential whatever the prevailing tank conditions. In such cases, sufficient BOG from the tank be obtained by running the LNG BOG vaporizer (i.e., a standard LNG ship equipment requirement)
- Additional laboratory and scaled-pilot tests are required to identify the optimum shapes sizes and materials to use for the floating elements. The system is still at the conceptual stage and requires further proving before deployment should be considered

## 8. Conceptual design for a wire-connected Anti-Sloshing Floating Soft Metal Blanket (ASFSMB) for membrane FSRU/FSU tanks

An ASFSMB is proposed specifically for FSRU/FSU moored at offshore locations prone periodically to high waves and with high sloshing risks particularly for vessels with membrane tanks. The sloshing phenomenon and the risks it poses to membrane tanks is well documented (Lloyds Register, 2009;

Sprenger, 2013; Liljegren and Lindahl, 2015). Gaztransport & technigaz (GTT) current membrane tank designs advocate reinforced insulation to deal with loads potentially subjected to substantial sloshing based on strength assessment tests (Bureau Veritas, 2011). Although some FSRU of 138,000 m<sup>3</sup> capacity are certified to be sloshing-free, larger FSRU with 150,000 to 180,000 m<sup>3</sup> capacity are not and, in practice, sloshing free is very conditional. Those larger vessels have specified limits imposed on their safe-operating liquid levels to prevent sloshing impacts, e.g., typically, they cannot operate with LNG-fill levels of between 10% and 70% of the tanks height during moderate to heavy seas. This significantly reduces their operational flexibility in many offshore locations.

The ASFSMB system proposed retains all the advantages of the FSMB and full-scale **Effects 1, 2 and 3 for tank pressure control benefit**, but is also effective in **tackling the sloshing issue** in a similar way to the anti boil-off gas anti-slosh (ABGAS) blanket (MarineLink, 2013; Lee et al., 2014, 2016) (Fig. 9), applying different materials and a distinct design concept. See optimal suggested design for such a system (Figs. 10 and 11). However, a cross-wire-connected metal blanket could also use the simpler buoyant partially-open sphere (ball) design already described (Fig. 4). Additionally, there may be the need to install strings of bumpers around the edges and on the upper surfaces of the blanket wings to protect the membrane tank walls from impacts. Depending on tank-wall strength data, bumpers may need to be distributed in strings above the upper surfaces of the blanket sections. These would minimize any impact of the wings and main panel against the tanks membrane walls and prevent damage.

The proposed ASFSMB design uses metal cylindrical shapes with a top floating condensing chamber and a lower portion that includes fins ended with rounded cup to act as an anchor to break up waves. These shapes are similar to those proposed for the FSMB but they are not independently free-floating. Instead, the individual elements are cross-connected by metal wire with different amounts of slack incorporated that maintains the structure of the blanket and allows superior flexibility. It has to accommodate being bent and dislodged at certain levels within the FSRU tanks (e.g., the upper hexagonal-shaped tank zone) and lessen the impacts on the tank wall during listing of the ship. It would consist of three sections connected with wire that is independent of the wire connecting the floating elements. The ASFSMB as a whole would use the tank tripod mast as guide slide when moving vertically within the tank (Fig. 12).

- The central component (within red boundary consisting of bumpers) is more rigid and encapsulated by the bumpers
- The two lateral wings are more flexible with slacker wire binding to allow higher deflection, following tank shape but preventing the individual floating components piling up or folding up. The blanket sections themselves are made so that they can flex and fold to a degree but not so flexible that they can fold back on themselves
- It is sized to cover, when flat, the maximum area of tank
- The tripod mast needs to be reinforced and fitted with sliding vertical bars

Fig. 12 illustrates conceptually the ASFSMB in detail. It consists of three parts, the shapes of which will vary depending on whether they are to fit tanks 2 to 4 or tank 1 (the bow tank). Appendix 3 provides more details on membrane tank geometries. The main central section and the side wings are connected together with slacker wire so that they can readily bend against each other as to better fit the shape of specific membrane tanks, in particular the chamfer and hopper regions of such tanks (Fig. 11). While each section of the ASFSMB has some flexibility it cannot be bent or folded completely. The crossing network of wires threaded through each of the floating metal components makes it a semi-flexible and semi-rigid structure. The soft bumper (shown in red in Figs. 11 and 12) are designed minimize impact on the tank walls and slopes avoiding impact damage. The bumpers are spring cylinders of wire mesh that form a soft frame around the central section of the ASFSMB and/or wings (Fig. 11). They are designed primarily to prevent damage to the top of the tank and chamfer zone (Fig. 13). Taking into account the design of the GTT NO. 96-membrane tank, with tongues in its membrane strip connections, the conceptual design for bumpers involves a fine metal mesh sleeve-bag filled with radial concentric metal springs structure across its full diameter (Fig. 12). The bumpers are numerous small sausage-shaped components rather than one single length.

Several detailed simulation models have highlighted the complexity of fluid movements during sloshing in LNG membrane tanks (Chen et al., 2009; Rudman et al., 2009; Sprenger, 2013; DNV-GL, 2016; Grotle and Esøy, 2018). These studies are relevant for blanket operational safety risks as they highlight certain areas of membrane tanks that are particularly vulnerable to the stresses resulting from sloshing impacts (Appendix 4, Fig. S4). For example, the vertical wall section in the widest part of the tank and the knuckles in the chamfers when the tanks are more than 90 percent full of LNG (Det Norske Veritas, 2016) (Fig. 14).

## 9. Potential problems and risks with proposed ASFSMB for offshore solutions

- Spray system nozzles need to be protected by covering them in tube-size mesh to prevent the ASFSMB potentially becoming snagged by them
- The ASFSMB could induce additional stresses on the tripod mast in both normal operations and in heavy seas; strength enhancement of the tripod mast may be required following detailed stress studies. The additional load on the mast could be significant (especially at lower tank filling levels), despite the blanket not being directly attached to tripod mast but having just its vertical movement guided by it
- Some parts of the blanket may touch the tank ceiling with sufficient buoyancy force due to its lateral wings being submerged in liquid. Its detailed design would need to ensure that the tank ceiling structure is not damaged

Rigorous computational fluid dynamics (CFD) testing of the system would be required to mitigate these problems/risks.

**Diagrammatic Illustration of the Anti-sloshing Effectiveness Claimed for the SHI-design ABAS Blanket in LNGC Prismatic Tanks**

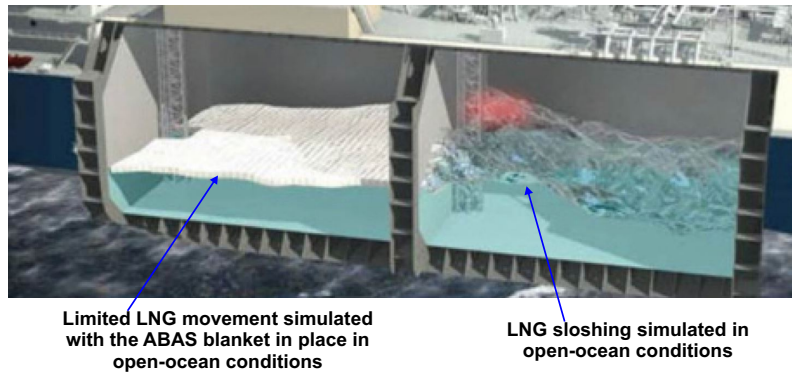

Fig. 9. ABAS blanket claims effectiveness as an anti-sloshing device. Modified after Lee et al. (2014).

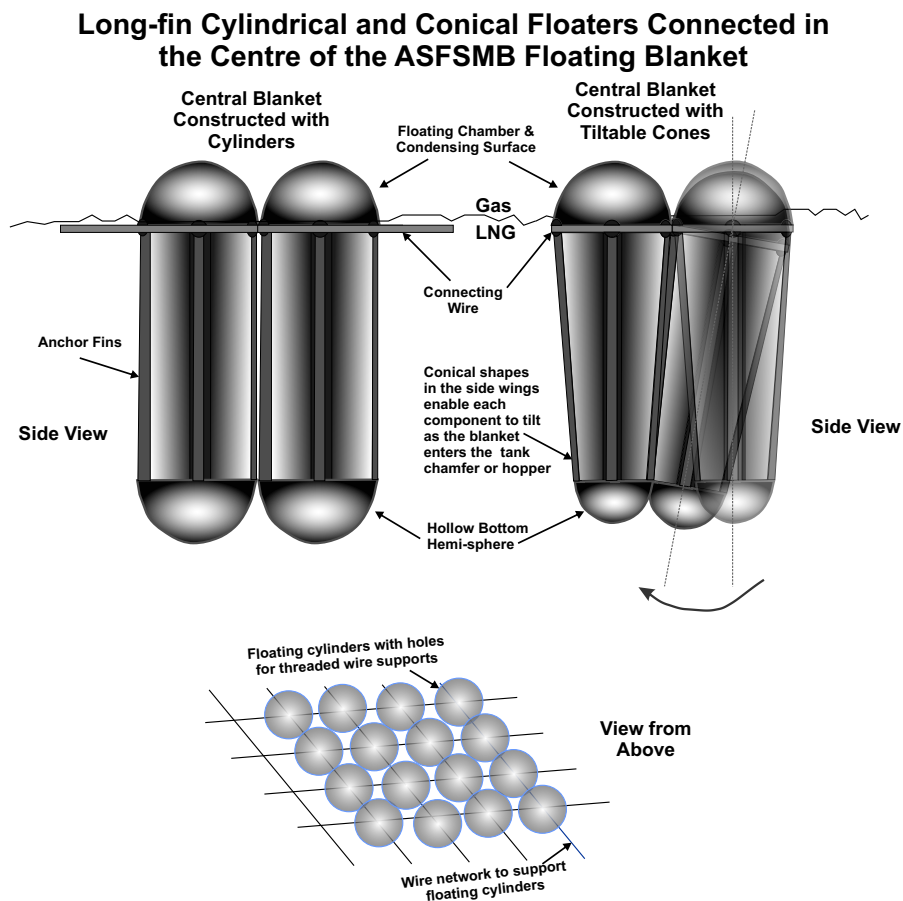
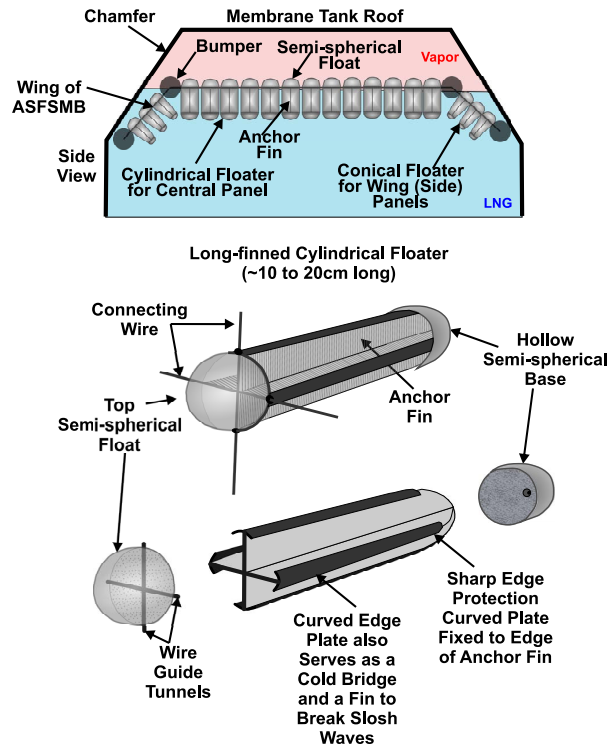

Fig. 10. Wire-connected anti-sloshing soft-metal blanket for FSRU/FSU membrane tanks. Cylinders and cones are likely to be more effective as anti-sloshing devices than spheres.

### Courgette-shaped Wire-connected Anti-sloshing Floating Metal Soft Blanket (ASFSMB) for LNG Membrane Tanks



**Fig. 11.** Courgette-shaped, wire-connected, anti-sloshing floating soft metal blanket (ASFSMB) design. This offers a heat-conducting alternative to the ABGAS.

### Components of A Wire-connected Anti-sloshing Floating Soft Metal Blanket (ASFSMB)

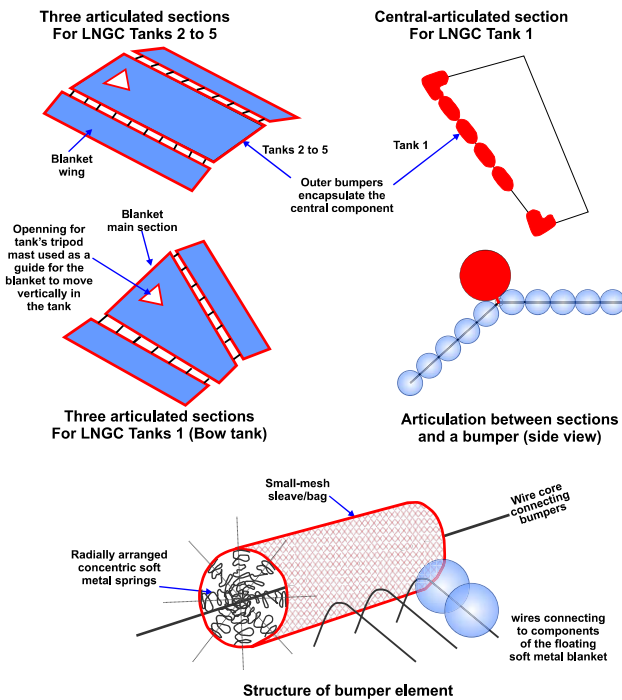

**Fig. 12.** Wire-connected anti-sloshing soft metal blanket structure for FSRU/FSU prismatic tank. It involves three components connected by wire, a central main part and two wings. The blankets exact shape depends on the membrane tank shape.

### LNGC Membrane Tank Geometries To be Dealt with by ASFSMB

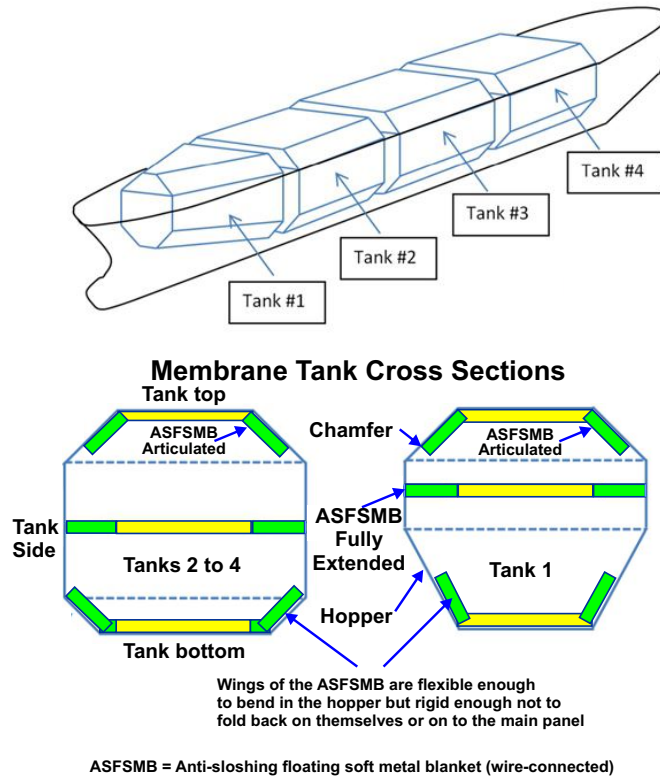

**Fig. 13.** The articulated ASFSMB involves three articulated components, a central, permanently flat section and two narrower wings that fold into the angles of the chamfer and hopper of membrane tanks as LNG fluid levels dictate.

### Typical Sloshing Event Impact Locations in LNGC Membrane Tanks at High Filling Levels

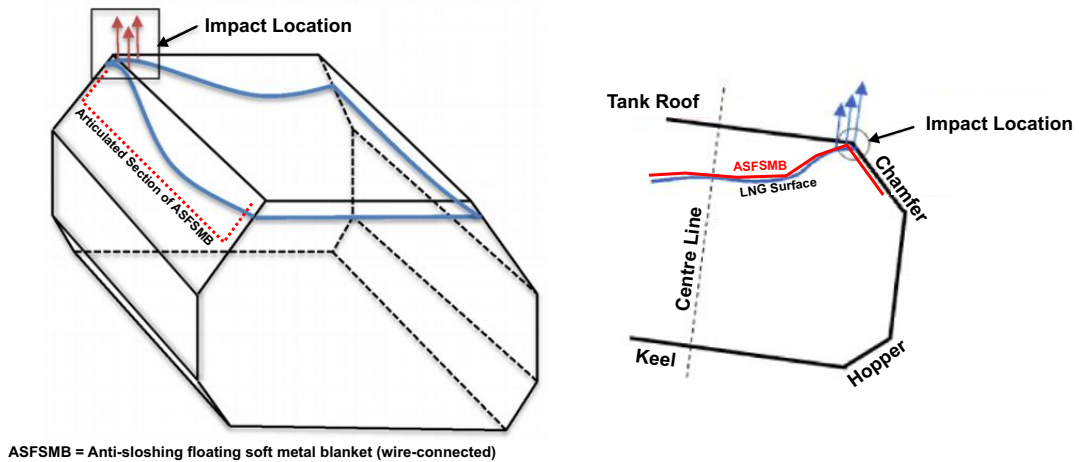

**Fig. 14.** Sloshing impact areas (i.e., the knuckles in the upper corners of the chamfers) in membrane tanks greater than about 90% full of LNG. Right diagram modified after DNV-GL (2016). For tanks with lower levels of fill, it is the vertical tank walls that are most vulnerable to damage from edge impacts by the ASFSMB (Fig. S4, Supplement 4).



### Pear-shaped, Spherical and Sayaendo Supported LNGC Tanks with Wire-connected Floating Soft Metal Blanket (WFSMB)

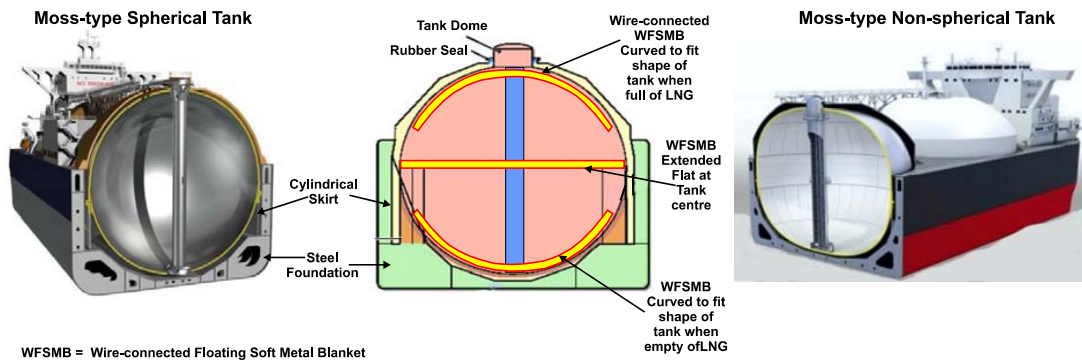

**Fig. 15.** MOSS-type rigid spherical and KHIs non-spherical shaped LNG tanks. Conceptual image of wire-connected blanket (WFSMB) in action in a MOSS-type tank. Left diagram (modified after: Mokhtab et al., 2014; Cult of Sea, 2017) and right diagram from (Kawasaki, 2017); *Liquefied Gas Carriers*, 2019

### Structure of Wire-connected Floating Soft Metal Blanket (WFSMB) Suitable for Moss-type FSRU/FSU Tanks

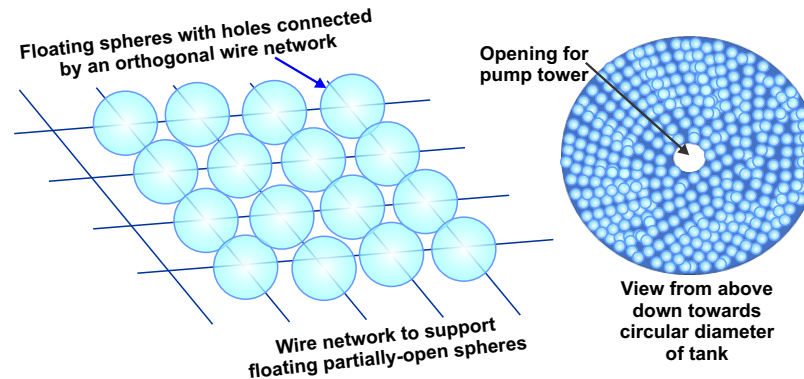

**Fig. 16.** Wire-connected blanket (WFSMB) shape and structure for MOSS type FSRU/FSU tanks consisting of buoyant partially-open sphere. Such a blanket is only needed for effective tank pressure control (section 3), not for anti-sloshing purposes.

## 10. Conceptual design for a wire-connected floating soft metal blanket (WFSMB) for tank pressure control for MOSS tanks type

WFSMB concept could also be a feasible enhancement in spherical named after Norwegian company Moss Maritime (MOSS)-type tanks and the latest developments of non-spherical MOSS designs (Kawasaki, 2017) (Fig. 15). The prime function of this wire-connected blanket is to enhance BOG and tank pressure control (effects 1, 2 and 3) not anti-sloshing. A soft wire-cross connected structure is needed due to the spherical or squashed spherical tank shapes. The WFSMB flexible wired blanket (Fig. 16) would be sized to fit the maximum diameter of such tanks and placed around the pump mast that would act as a guide pin. The pump mast is located in the centre of MOSS tanks. The WFSMB would float and be slack enough for its wire framework to bend to fit the tank shape for whatever prevailing level of LNG it contained (Fig. 15). It would be designed to buckle in and out from its flat position when the LNG level is at the tank middle. MOSS

spherical tanks and the new Kawasaki Heavy Industries (KHI) MOSS non-spherical tank designs are free from sloshing issues by design. This would prevent excessive piling up and tank capacity reduction by the metal balls and or buoyant partially-open-spheres (Fig. 4) in upper part of tank that would occur with the free-floating design (FSMB) described for membrane tanks (Fig. 4).

## 11. Conclusions

An innovative concept is developed to solve the limited tank pressure control flexibility inherent in FSRU/FSU with low MARVS tank ratings. Conceptual designs of a metal blanket made up of many small metal floating components placed on the liquid surface in LNG tanks highlights how such a system might be best configured. As conceived the system has the potential to increase tank safety (i.e., reduce the risk of excessive overpressures arising) and to reduce or eliminate wasteful on-board cargo consumption associated with the ongoing control of tank pressure. It does this by reducing consumption, otherwise inevitable in the gas combus-

tion unit/stem dump (GCU/SD), leading to better commercial performance.

The FSMB should be easy and relatively cheap to fabricate, with small installation capital costs for tank modifications. Once in place, the system would involve no additional costs to operate. It would be of particular benefit for LNGC conversions to FSRU/FSU, because of the low MARVS ratings of their tanks and stationed in sheltered waters. The solution is potentially feasible for membrane prismatic tanks, but not spherical (MOSS) tanks. It could also provide beneficial boil-off handling in land-based cylindrical LNG tanks. The FSMB may also work for international maritime organization (IMO) A and B type (IHI SPB), non-spherical, rigid, prismatic tanks, as well as being scalable to use in small vessels and small LNG fuel tanks.

The concept exploits the complex pressure duality behavior of LNG in contact with its vapor space that naturally evolves during FSRU/FSU tank operations. Such a simple solution makes the liquid surface in LNG tanks a BOG emission restrictor, thereby maintaining tank pressure dynamically at a level significantly below the SVP of the LNG bulk (*tank pressure dip*). Additionally, it creates an effective heat exchanger on the LNG surface that enhances condensation from the vapor space in cases of overpressure resulting in packed conditions being short lived. The tank pressure is inhibited from rising significantly above the SVP of the LNG bulk (*tank pressure sag*), as it would do without a floating metal blanket operating.

Wire inter-connected floating metal blanket conceptual designs are described that could be deployed as anti-sloshing devices (in offshore locations) as well additionally providing the same enhanced tank pressure control as the FSMB. Such designs could also be deployed to enhance tank-pressure control in FSRU/FSU MOSS-type tanks.

As the designs and impacts described are conceptual, detailed design and rigorous laboratory tests are required to further evaluate them and provide the appropriate design specifications and performance details.

## Conflict of interest

This research has received no funding and the authors have no conflicts of interest to declare.

**Open Access** This article is distributed under the terms and conditions of the Creative Commons Attribution (CC BY-NC-ND) license, which permits unrestricted use, distribution, and reproduction in any medium, provided the original work is properly cited.

## References

- Bates, S., Morrison, D.S. Modelling the behaviour of stratified liquid natural gas in storage tanks: A study of rollover phenomenon. *Int. J. Heat Mass Transf.* 1997, 40(8): 1875-1884.
- Bureau Veritas. Strength assessment of LNG membrane tanks under sloshing loads. Guidance Note NI 564 DT R00 E. Marine Division, Neuilly sur Seine, France, 2011.
- Cengel, Y., Ghajar, A.J. *Heat and Mass Transfer: Fundamentals and Applications*. 5th Edition, New York, UAS, McGraw-Hill, 2014.
- Chen, Y., Price, W.G., Temarel, P. Numerical simulation of liquid sloshing in LNG tanks using a compressible two-fluid flow model. Proceedings of the 19th International Offshore and Polar Engineering Conference, Osaka, Japan, 21-26 June, 2009.
- Cook, J. Flex LNG: The next generation of LNG carriers. Marine Money Week Conference, New York, UAS, 19-21 June, 2017.
- [Cult of Sea. Gas tanker-Types, tanks, reliquefaction and cargo handling operations. 2017.](#)
- Deshpande, K.B., Zimmerman, W.B., Tennant, M.T., et al. Optimization methods for the real-time inverse problem posed by modelling of liquefied natural gas storage. *Chem. Eng. J.* 2011, 170(1): 44-52.
- Det Norske Veritas. Sloshing Analysis of LNG Membrane Tanks. Oslo, Norway, DNV Classification Notes, 2016.
- DNV-GL. LNG containment systems: Finding the way for Type A. *Maritime Impact*, 2019.
- Grotle, E.L., Esoy, V. Dynamic modelling of the thermal response enhanced by sloshing in marine LNG fuel tanks. *Appl. Therm. Eng.* 2018, 135(5): 512-520.
- [GTT. LNG membrane tank technology provider, 2019.](#)
- Hashemi, H.T., Wesson, H.R. Cut LNG storage costs. *Hydrocarbon Process.* 1971, 50(1): 246-249.
- Howard, B.C. Why did L.A. drop 96 million 'shade balls' into its water? *National Geographic* 2015.
- [Kawasaki develops new moss-type tank for LNG transport vessels, obtains AIPs from three key organizations, 2017.](#)
- Kulitsa, M., Wood, D.A. LNG cargo handling (Part 1): New approach improves ship-to-ship LNG transfers. *Oil Gas J.* 2017a, 115(11): 56-60.
- Kulitsa, M., Wood, D.A. LNG cargo handling (Conclusion): Tandem pressures between ships during STS transfers cuts gas losses. *Oil Gas J.* 2017b, 115(12): 65-70.
- Kulitsa, M., Wood, D.A. Part 1: Improved monitoring onboard FSRUs is required to enhance operating performance and cut cargo loss. *LNG J.* 2017c, 22-24.
- Kulitsa, M., Wood, D.A. Part II: Improved monitoring onboard FSRUs is required to Enhance operating performance and reduce cargo losses. *LNG J.* 2017d, 22-25.
- Kulitsa, M., Wood, D.A. LNG rollover challenges and their mitigation on Floating Storage and Regasification Units: New perspectives in assessing rollover consequences. *J. Loss Prevent. Proc.* 2018, 54: 352-372.
- Kulitsa, M., Wood, D.A. Duality in LNG tank-pressure behaviour and its relevance for ship-to-ship transfers to Floating Storage and Regasification Units (FSRU). 2020 (undergoing peer review).
- Laciak, M. Liquefied natural gas storage of variable composition. *Arch. Min. Sci.* 2015, 60 (1): 225-238.
- Lee, D.H., Ha, M.K., Ki, S.Y., et al., Research of design challenges and new technologies for floating LNG. *Int. J. Nav. Archit. Ocean Eng.* 2014, 6(2): 307-322.
- Lee, M.S., Chung, C., Lee, S.G., Sloshing reduction using floating mat for floating LNG cargo containment system. Paper OTC-26793 Presented at Offshore Technology Conference Asia, Kuala Lumpur, Malaysia, 22-25 March, 2016.

- Liljegren, A., Lindahl, O. Sloshing impact response in LNG membrane carriers. Masters Thesis 2015: X-15/329. Gothenburg, Chalmers University of Technology, 2015.
- Liquefied Gas Carrier. Dual fuel diesel electric propulsion systems LNG carriers-Electric transmission losses & fuel cost, 2019.
- Liquefied Gas Carrier. LNG vessel construction-Advantages of Moss Rosenberg technology, 2019.
- Lloyds Register. Sloshing assessment guidance document for membrane tank LNG operations, 2009.
- Marine Link. LNG ABAS blanket: Samsung heavy improve design, 2013.
- Mokhatab, S., Mak, J.Y., Valappil, J.V., et al. Handbook of Liquefied Natural Gas. Oxford, UK, Gulf Professional Publishing, 2014.
- Olsen, E.S. The best of both worlds. *ABB generations: Technical insight*. 2016, 94-99.
- Paine, S.N., Turner, D.D., Kuchler, N. Understanding thermal drift in liquid nitrogen loads used for radiometric calibration in the field. *J. Atmosph. Ocean Technol.* 2014, 31: 647-655.
- Pandey, R. Conceptual design for LNG storage tank. Mechanical Engineering, 2017 (March, online image).
- Polinski, J. *Materials in cryogenics*. Wroclaw University of Technology, 2010.
- Rudman, M., Prakash, M., Cleary, P.W. Simulation of liquid sloshing in a model LNG tank using smoothed particle hydrodynamics. Paper ISOPE-I-09-540 Presented at 19th International Offshore and Polar Engineering Conference, Osaka, Japan, 21-26 June, 2009.
- Sprenger, F. *Jahrbuch der Schiffbautechnischen Gesellschaft*. Berlin, Heidelberg, Springer, 1906.
- Weyburne, D. A mathematical description of the fluid boundary layer. *Appl. Math. Comput.* 2006, 175: 1675-1684.
- Weyburne, D. New thickness and shape parameters for describing the thermal boundary layer. arXiv: 1704.01120, 2018.
- Wood, D.A., Kulitsa, M. A review: Optimizing performance of Floating Storage and Regasification Units (FSRU) by applying advanced LNG tank pressure management strategies. *Int. J. Energy Res.* 2018, 42(4): 1391-1418.

## Appendix 1 Sagged pressure trend during LNG ship-to-ship (STS) transfer to FSRU

### LNG Temperature, Tank Pressure and Level Trends in FSRU during STS Transfer with Packing Conditions

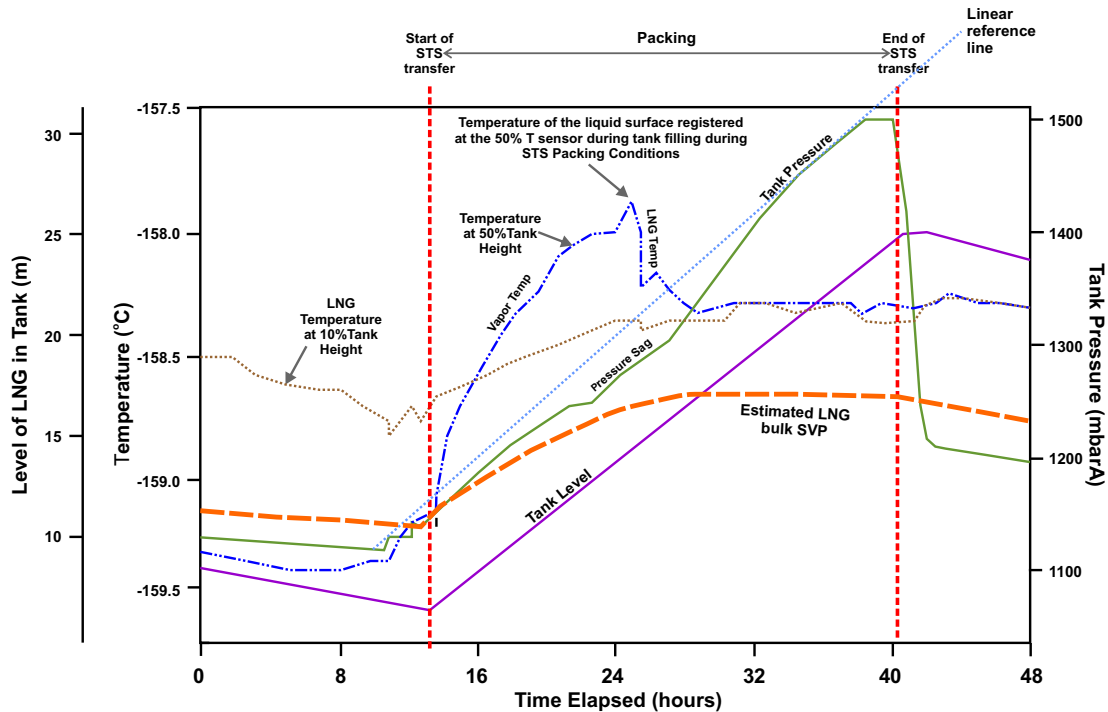

**Fig. S1.** Sagged tank pressure and temperature trends during packing conditions for STS mix case (no stratification formed) in overpressure condition observed during actual FSRU STS operations without a surface blanket.

The effect of a disturbed surface film is depicted in Fig. S1. In simple terms, the LNG surface film is limited in mass and is undergoing heat exchange with the vapor space with fast visible results compared to the underlying LNG bulk. The LNG bulk mass is much larger than the surface film and cannot participate as a whole in immediate heat exchange with the vapor space. The convective currents generated in the LNG bulk mass by heat ingress from the tank walls, constantly brings some mass of LNG bulk to just below the surface film where heat exchange with the vapor space is actively going on. Consequently, the effect of heat exchange on the LNG bulk occurs at a slower pace. This can result in substantial differences in the physical states of the LNG surface film compared to the LNG bulk at specific points in time.

When the tank is packed (i.e., overpressure condition with tank pressure higher than the SVP of the LNG bulk), the LNG film incrementally absorbs small masses of vapor and rapidly saturates to new higher pressures (raising SVP of the surface film, while the SVP of the LNG bulk remains broadly unchanged during this short period of time). Eventually, this effect becomes noticeable with the LNG film acting as a piston head. Such pressure trends are readily observed as a tanks vapor space is progressively compressed like vapor existing alone in a cylinder.

When the very thin surface film is constantly disrupted, damaged or fragmented for any reason, then much more vapor is in direct contact with the LNG bulk and can be absorbed by it. This leads to a larger mass of vapor being condensed on the (bulk) LNG surface causing the pressure sag depicted on Fig. S1. In that particular observed case, the LNG surface was disturbed during the STS transfer when LNG was loaded into the bottom of the tank. That light, newly introduced, LNG mixes with the heavy LNG heel already in the tank and rises upwards due to buoyancy. When it reaches the LNG surfaces it destroys and breaks through the surface film at some places across the vapor-LNG interface. Once the STS transfer is about 50-percent completed the density contrast between the new LNG introduced and the in-tank-mix LNG diminishes. This causes the upward buoyant forces acting on the light LNG to also be diminished and the surface film becomes less disturbed. The overall consequence of the resulting sagged pressure trend is that it takes longer for tank pressure to reach the operational pressure limits set for the tank. This provides the operators more time and flexibility to respond to and manage that upward tank pressure trend and delays the usage of GCU/SD, thereby saving energy.

## **Appendix 2 Alternative shapes initially considered for free-floating soft metal components and subsequently rejected for various reasons**

Alternative shapes for the floating elements that were initially evaluated were shapes suited to cylindrical land-based LNG storage tanks.

- 1 Flying saucer with rounded upper and lower profiles
- 2 Spinning top with sharper upper and lower profiles than shape 1
- 3 Dull cones (i.e., smoothing the sharper projections of shape 2 for safety reasons)
- 4 Dull cones with a hexagonal profile at the central diameter that would float at the surface of the liquid film
- 5 Parachute or mushroom-a one-sided floating element with a heavier and sharper, stalk-like, bottom projection that would pierce deep into the LNG bulk

Clearly, such geometries are best suited as free-floating components in shore-based tanks as they have cylindrical vertical walls. In such tanks there is no potential for piling up of the free-floating to accommodate, unlike in FSRU prismatic and Moss-type tanks.

In detailed laboratory tests of the effectiveness of specific free-floating elements, it would be worthwhile evaluating some of these geometric shapes in LNG tanks under controlled conditions. This would determine how each shape performs relative to ball-shaped geometries in terms of their tank-pressure-control capabilities.

### Appendix 3 Different Geometries of LNGC /FSRU /FSU Tanks

#### LNGC Membrane Tank Geometries

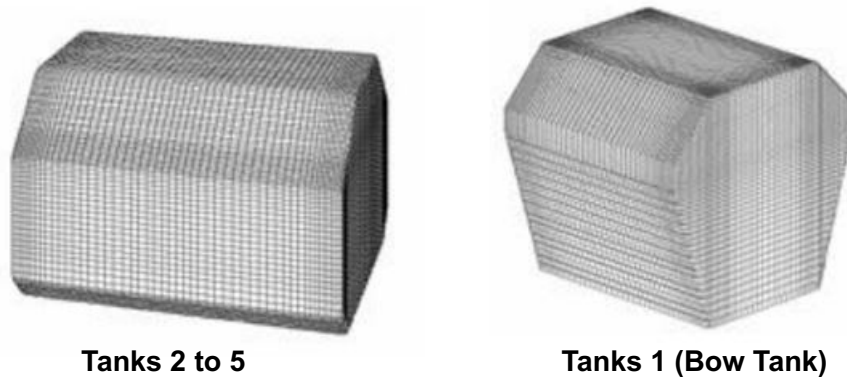
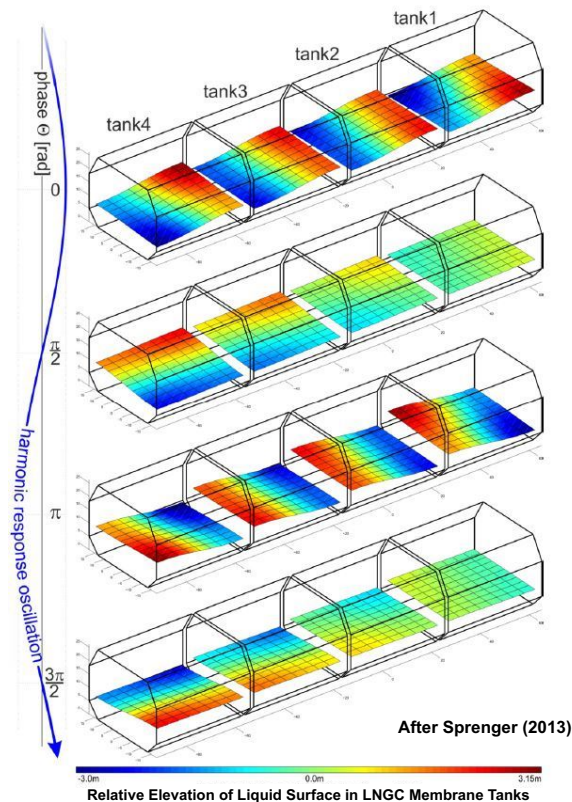

**Fig. S2.** Distinctive geometries of tanks 2 to 5 and the bow tank (tank 1) in membrane LNGC and FSRU.

The membrane tank shape of typical FSRU/LNGC tanks from 2 to 4 or 5 consists of a regular prismatic geometry. On the other hand, tank 1 often has an irregular prismatic form due to the constraints of the bow design of the ship. The typical tank 1 shape has a geometric form that is less favourable for a wire-connected floating soft metal blanket (WFSMB) to operate within it. The narrower lower part of tank 1 requires a more flexible wire-connected blanket than the other tanks. Establishing the optimal flexibility of a wire-connected blanket for tank 1 would be crucial for it operate safely and effectively in any conditions of service. If the wire-connected blanket was made to be too flexible there is a risk that it could fold over on itself in the hopper region of tank 1. If that occurred, it could not be easily unfolded without entering the tanks in a shipyard.

## Appendix 4 Complexity of sloshing in LNGC in open sea conditions

### Complexity of 3-D Sloshing of LNG Modelled in LNGC Membrane Tanks at 30% Filling Heights for a Frequency of 0.74 rad/s at Four Steps in the Harmonic Oscillating Response



**Fig. S3.** 3-D modelling of sloshing in simulated ocean conditions highlights the complexity of LNG liquid movements inside LNGC and FSRU membrane tanks. modified after Sprenger (2013).

In the absence of rigorous tests in a float chambers simulating and testing conditions in rough seas, it is considered doubtful that the wire-connected soft metal floating blanket concept could operate safely and effectively in membrane LNGC without risking damage to the membrane tank walls. At this conceptual stage, it is considered feasible for FSRU/FSU and shore-based tanks. The problem of deploying the concept in membrane LNGC subjected to rough seas is that existing membrane tanks have relatively weak tank walls. In the case of side rolling, there are extreme conditions in which the whole mass (concentrated in blanket cross section end, not its upper flat side) of the WFSMB could be pushed against the LNGC membrane tank wall, potentially damaging it. The problem is that the blanket wings or edges could be forced against the wall laterally with a significant portion of the weight of the blanket behind that impact. This could potentially constitute a large force, particularly in situations of initial contact with wall and where the blanket is contorted into the limit of its flexibility (Fig. S4). The current design of the WFSMBs position in a tank is only guided at one side by the pump tower and not otherwise constrained. In such conditions it would not be possible to easily mitigate the risk of damage to the tank in rough seas, on its free not guided side, without engaging in expensive modifications to the tank effectively constraining the WFSMB. For example, by placing a guide column in the forward part of tank to restrict blanket movements and prevent high-force impacts against the membrane walls.

Most FSRU/FSU are moored in more sheltered offshore locations. Also when rough sea condition occur their mooring is so designed to keep their bows always facing into the waves. This means that the vessels movements on the water are dominated by pitching and are therefore not subjected to large rolling motions experienced by LNGC in rough seas while sailing. These ship movements cause the blanket to touch the tank walls with limited mass from its upper face; not its edges. Also, the offshore locations in which FSRU/FSU are typically moored near shore on the shallow continental shelf where even high waves have relatively short wavelengths. Such waves do not cause severe vessel movements such as surging and excessive accelerations that occur during sailing in open ocean locations.

Experiencing primarily heaving and pitching motions, the WFSMB would touch the membrane tank walls along the large cross-sectional areas of its edges which are protected by bumpers. Such impacts should not involve excessive forces. It is

therefore considered that the heaving and pitching motions experienced by FSRU/FSU generally would not pose tank safety issues when deploying the WFSMB, as the blanket would be adequately constrained and guided by the tripod mast of the pump tower.

**Severe Rolling Motions of LNGC Membrane Tanks in Rough Seas  
Risk Tank Damage with ASFSMB**

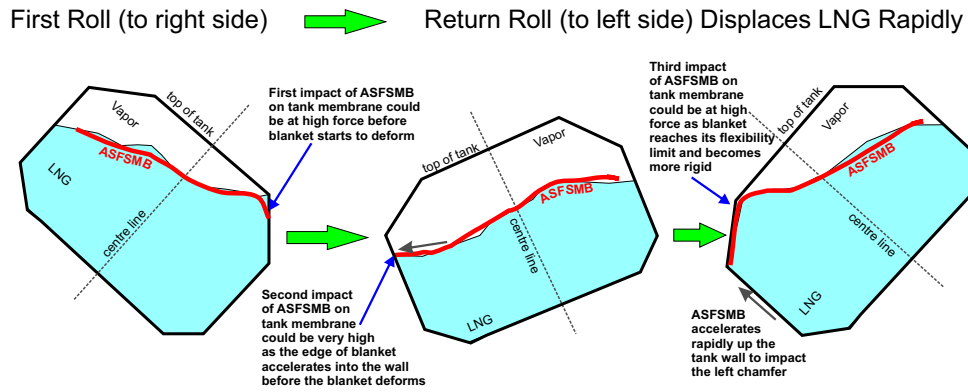

**Fig. S4.** Potential for tank damage with ASFSMB in LNGC membrane tanks due to extreme rolling motions in rough seas.